



# S9502-16SMT

Disaggregated Cell Site  
Gateway Router

**Hardware Installation Guide**

R1.5





# Table of Contents

<b>1</b>	<b>Overview</b> .....	<b>1</b>
<b>2</b>	<b>Preparation</b> .....	<b>2</b>
2.1	Installation Tools.....	2
2.2	Installation Environment Requirements .....	3
2.3	Preparation Check List .....	4
<b>3</b>	<b>Package Contents</b> .....	<b>5</b>
3.1	Accessory List.....	5
3.2	Component Physical Information .....	6
<b>4</b>	<b>Identifying Your System</b> .....	<b>7</b>
4.1	S9502-16SMT Overview.....	7
4.2	DC Version PSU Overview .....	8
4.3	AC Version PSU Overview .....	8
4.4	Port Overview .....	8
<b>5</b>	<b>Rack Mounting</b> .....	<b>9</b>
<b>6</b>	<b>Grounding the Router</b> .....	<b>11</b>
<b>7</b>	<b>Connecting Power</b> .....	<b>13</b>
7.1	DC Version .....	13
7.2	AC Version.....	14
<b>8</b>	<b>Verifying System Operation</b> .....	<b>15</b>
8.1	Front Panel LED.....	15
8.2	Management port LED.....	16
<b>9</b>	<b>Initial System Setup</b> .....	<b>17</b>
<b>10</b>	<b>Cable Connections</b> .....	<b>18</b>
10.1	Connecting the USB Extender Cable.....	18
10.2	Connecting a Cable to the ToD Interface .....	18
10.3	Connecting the 1PPS Interface .....	19
10.4	Connecting the 10MHz Interface.....	19
10.5	Connecting the Transceiver .....	19
<b>11</b>	<b>Cautions and Regulatory Compliance Statements</b> .....	<b>21</b>



# 1 Overview

The UfiSpace S9502-16SMT is a high-performance, versatile open networking white box router that is designed to address the changing needs of backhaul transport requirements as telecoms make the transition from legacy technologies towards 5G.

It enables telecoms and service providers to deploy disaggregated open network infrastructure to lower costs and rapidly scale existing services for edge computing, mobile backhaul, and broadband access applications.

The S9502-16SMT has a lightweight design without fans and fixed power supplies to reduce moving parts and enable longer lasting operations with minimal maintenance servicing. It has a powerful dual-core processor, 100M/1G/10G high-speed interfaces, and timing features supporting IEEE 1588v2 and SyncE, which enables service providers to easily migrate from 2G, 3G, 4G BBUs to 5G.

This document describes the hardware installation process for S9502-16SMT.



## 2 Preparation

### 2.1 Installation Tools



Screwdriver (Phillips head #2)

Phillips #2 Screw Driver

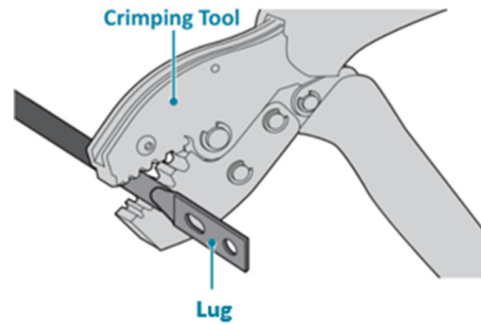

Crimping Tool



18-AWG wire with ring terminal for DC power supply

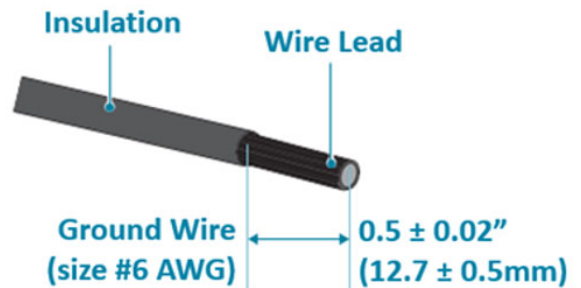

6-AWG green-and-yellow wire for grounding



Wire-stripping tools for stripping 6-AWG copper wire

Console cable

- PC with terminal emulation software. Refer to the "Initial System Setup" section for details.
  - Baud rate: 115200 bps
  - Data bits: 8
  - Parity: None
  - Stop bits: 1
  - Flow control: None

## 2.2 Installation Environment Requirements

- Power Reserve: The S9502-16SMT power supply is available with:
  1. **DC Version:** 1+1 active-active -36 to -75V DC power supply field replaceable unit or;
  2. **AC Version:** 1+1 active-active universal 100 to 240V AC power supply field replaceable unit.

To ensure the active-active feed power design functions properly, a field with dual power circuit is recommend with a reserve of at least 120 watts on each power circuit.

- Space Clearance: The S9502-16SMT width is 17.32 inches (44cm) and shipped with a rack mount brackets suitable for 19 inch (48.3cm) wide racks. The rack mount brackets can be installed at the front or in the center of the S9502-16SMT. The depth of the S9502-16SMT chassis is 9.84 inches (25cm). The connectors for the power supplies and interfaces will extend outwards from the front panel by 0.55 inches (1.4cm). To allow adequate airflow and space for cable connections, it is recommended a 3 inch (7.62cm) clearance in the front and a 5 inch (12.7cm) clearance in the back of the unit. The total minimum reserve depth is 17.84 inches (45.32cm). When deploying the S9502-16SMT in environments where the operating temperatures may be between 113°F and 149°F (45°C and 65°C), please allow a 1.71 inches (43.5mm, 1RU) space clearance above and below the unit.

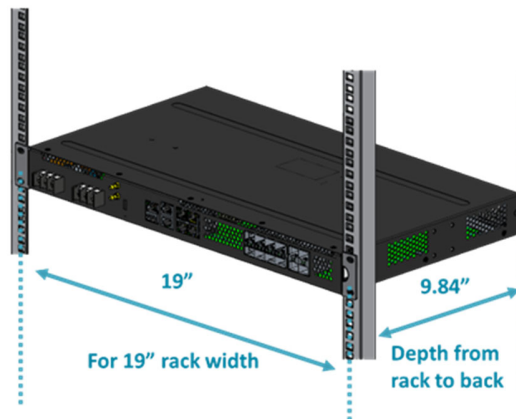

Figure 1.

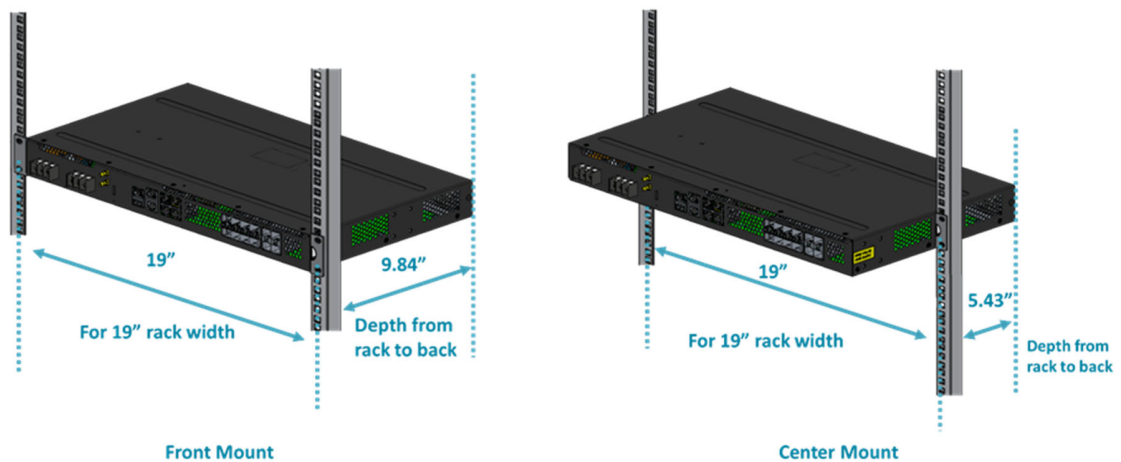

Figure 2.

- Cooling: The S9502-16SMT has a fanless design so the rack or cabinet must have a minimum of 3.28 feet/second (1 meter/second) airflow in any direction without recirculation.



Figure 3.

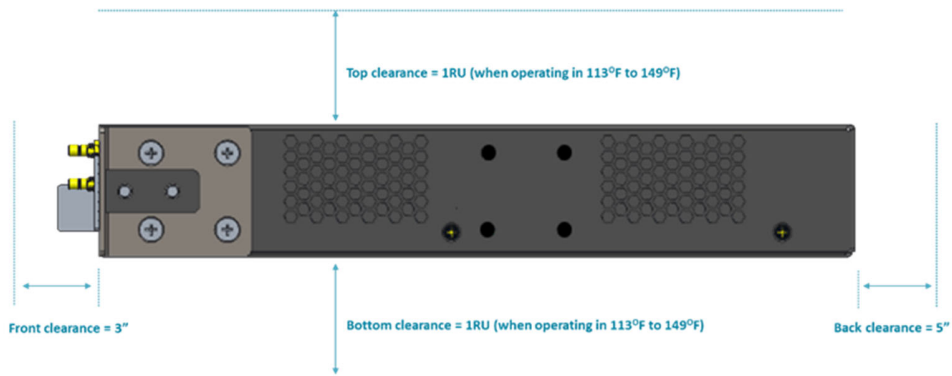

Figure 4.

## 2.3 Preparation Check List

Task	Check	Date
<b>Power voltage and electric current requirement</b> <b>DC version:</b> -36 to -75V DC, 4.5A maximum x2 or; <b>AC version:</b> 100 to 240V, 2A maximum x2		
<b>Installation spacing requirement</b> S9502-16SMT spacing requires a height of 1RU (1.75"/4.5cm), a width of 19" (48.3cm) in width, and a depth of 17.84 inches (45.32cm)		
<b>Thermal requirement</b> S9502-16SMT working temperature is -40 to 65°C (-40°F to 149°F), airflow direction is front-to-back and back-to-front		
<b>Installation tools required</b> #2 Philips Screwdriver, 6-AWG wire stripper, and crimping tool		
<b>Accessories required</b> PC with terminal emulation software, console cable, 18-AWG wire with ring terminal for power, 6-AWG wire for grounding		



## 3 Package Contents

### 3.1 Accessory List

Item	Description	Spec. & Dimensions	Qty.	Weight
1	Grounding Lug	1x Grounding Lug (#6 AWG) 1.97" x 0.44" x 0.30" (50 x 11.1 x 7.6mm)	1 pcs	0.022lb (10.0g)/pcs
2	Screw Kit (for Grounding Lug)	2 x Screws M4*L8.0mm 4 x M4 Lock Washers	1 set	0.008lb (3.5g)/set
3	Rack Mount Bracket	1.98" x 1.69" x 0.79" (50.4 x 43 x 20mm) (19" width rack)	2 pcs	0.14lb (65.4g)/2pcs (0.07lb (32.7g)/pcs)
4	Screw Kit (for Rack Mount Bracket)	8 x Screws M4.0*L6.5mm	1 set	0.02lb (7g)/set
5	USB 2.0 Type A Cable	7.87" (200mm)	1 pcs	0.02lb (10.5g)/pcs
6	AC Power Cord (AC version only)	72.05" (1830mm)	2 pcs	0.91lb (414g)/pcs (0.46lb (207g)/pcs)
7	RJ45 to DB9 Female Cable	95.98" (2438mm)	1 pcs	0.23lb (105g)/pcs

## 3.2 Component Physical Information

Specification	Item	Description
Weight	Total package contents	15.65lbs (7.1kg)
	Chassis without FRU	9.52lbs (4.32kg)
	Ground lug	0.022lbs (10g)
	Rack mount bracket	0.07lbs (32.7g)
	AC power cord (AC version only)	0.46lbs (207g)
	USB extension cord	0.02lb (10.5g)
	RJ45 to DB9 female cable	0.23lbs (105g)
	Screw kit for ground lug	0.008lbs (3.5g)
	Screw kit for rack mount bracket	0.02lbs (7g)
Dimension	S9502-16SMT (W x D x H)	17.32" x 9.84" x 1.71" (440 x 250 x 43.5mm)





## 4 Identifying Your System

### 4.1 S9502-16SMT Overview

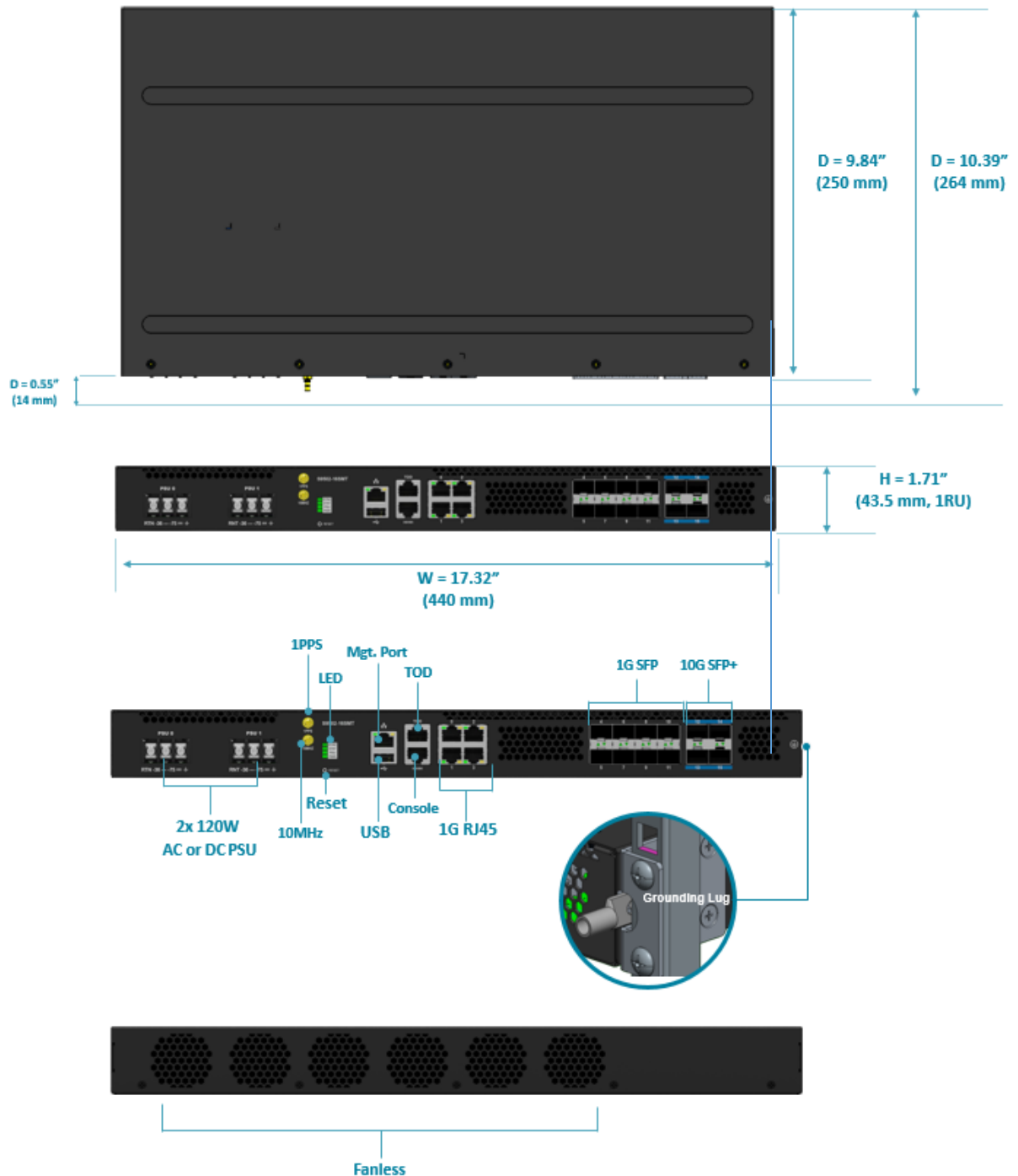

Figure 5.

## 4.2 DC Version PSU Overview

1+1, Fixed power supply unit (PSU).



Figure 6.

## 4.3 AC Version PSU Overview

1+1, Fixed power supply unit (PSU).



Figure 7.

## 4.4 Port Overview

Port ID	Form Factor	Maximum Support Distance	Support Speed
0 ~ 3	RJ45	238.01ft (100m)	100M/1G
4 ~ 11	SFP	43.49mi (70km)	100M/1G
12 ~ 15	SFP+	49.71mi (80km)	1/10G

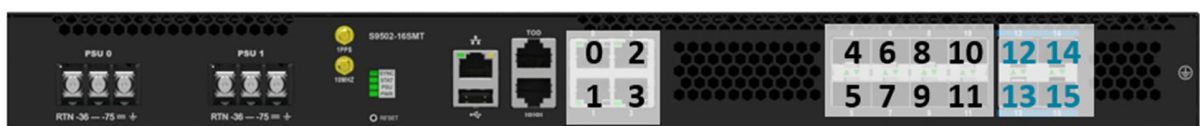

Figure 8.



## 5 Rack Mounting



It is recommended that installation be done by two trained professionals. One individual should hold the equipment in position on the rack while the other secures it in place.

1. Secure the rack mount brackets onto the router.  
Align the rack mount brackets with the holes provided on the both sides of the case and secure the brackets using the 8 M4.0\*L6.5mm screws provided with the package.



Figure 9.

2. Secure the router onto the rack posts.  
Mark the location on both posts to ensure it is leveled before securing the router onto the rack. (See Figure below).



Illustrations are for reference purposes only. Actual scenario may differ. Screws for rack posts not included.



Figure 10.

For rack post widths wider than 19", different brackets are available upon request (See Figure below).

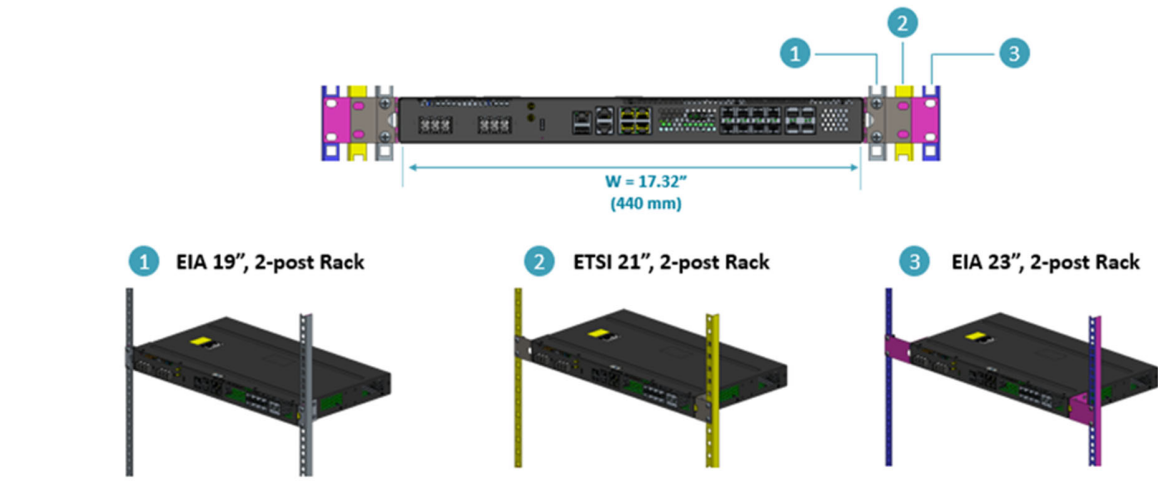

Figure 11.



## 6 Grounding the Router

It is recommended that equipment changes be done on a grounded rack system. This will reduce or prevent the risk of shock hazards, equipment damage, and potential of data corruption.

The router can be grounded from the router's case and the power supply units (PSUs). When grounding the PSUs, ensure that both PSUs are grounded at the same time. A grounding lug, M4 screws, and washers are provided with the package contents, however, the green-and-yellow grounding wire is not included.

The following instructions are for grounding the router.



This equipment must be grounded. Do not defeat the ground conductor or operate the equipment without correctly grounding the equipment. If there is any uncertainty about the integrity of the equipment's grounding, please contact the electrical inspection authority or a certified electrician.

1. Before grounding the router, ensure that the rack is properly grounded and in compliance with local regulatory guidelines. Ensure that there is nothing that can obstruct the connection for grounding and remove any paint or materials that may prevent good grounding contact.
2. Strip the insulation from a size #6 AWG grounding wire (not provided within the package contents), leaving 0.5" +/- 0.02" (12.7mm +/- 0.5mm) of exposed grounding wire.
3. Insert the exposed grounding wire all the way into the hole of the grounding lug (provided with package contents).
4. Using a crimping tool, firmly secure the grounding wire to the grounding lug.

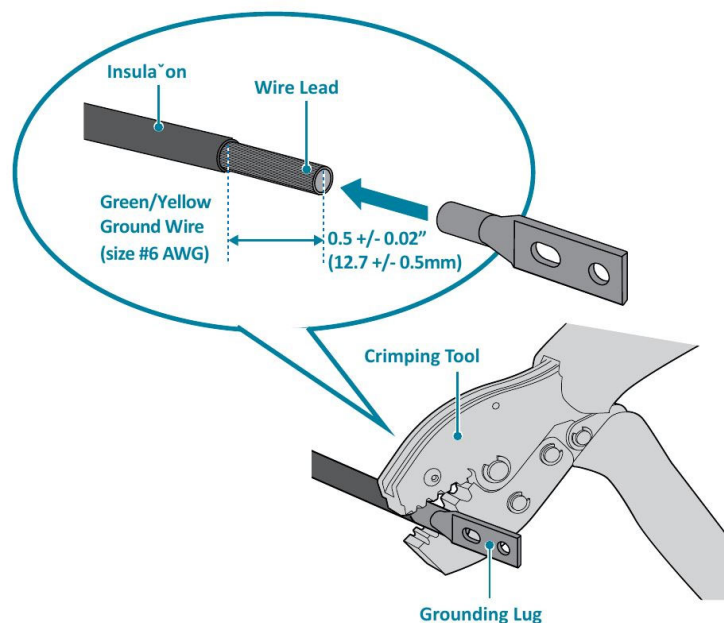

Figure 12.

5. Locate the designated location for securing the grounding lug, which is located on the side of the router.
6. Using 2 M4 screws and 4 washers (provided with the package contents), firmly lock the grounding lug to either of the designated grounding locations on the router.

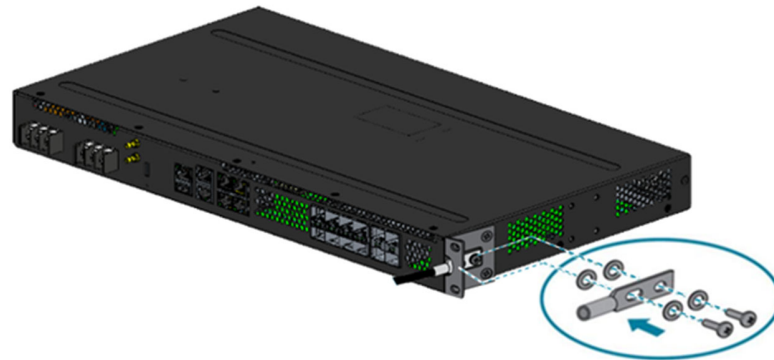

Figure 13.

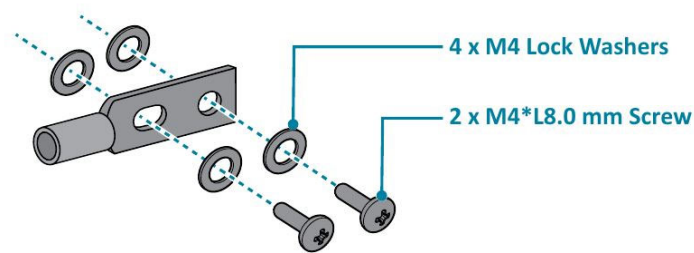

Figure 14.

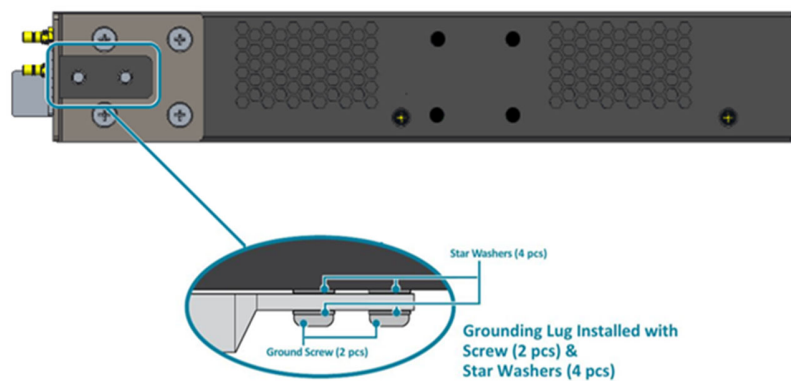

Figure 15.



## 7 Connecting Power

### 7.1 DC Version

1. Ensure there is enough power to supply the system.  
The maximum system power consumption is 52 watts. It is recommended to ensure that enough power is reserved from the power distribution system before installation.
2. Attach the power cable.  
Locate the DC power screw-type terminal block on the DC PSU. Attach the UL 1015, 18 AWG DC power cable (not provided within the package contents) to the DC inlet connector on the PSU.



Dangerous voltage!

- Must be powered off before removing!
- Verify that all electrical connections are grounded before powering on
- The DC power source must be reliably grounded

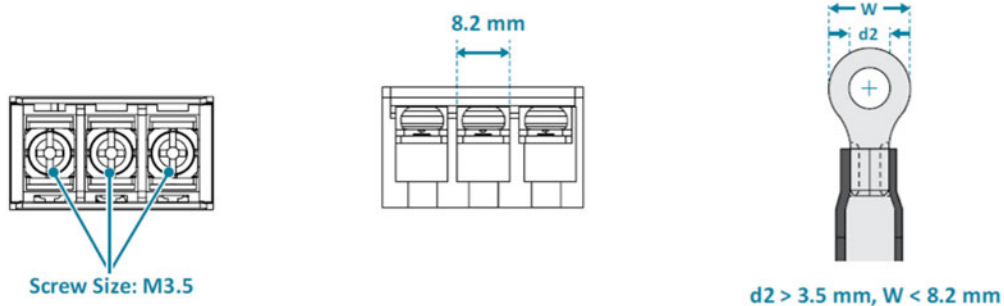

Figure 16.

3. Tighten the screws to the specified torque.  
Tighten the screws to a torque value of 7.0+/-0.5kgf.cm. If the torque is not enough, the lug will not be secure and may cause malfunctions. If the torque is too much, the terminal block or lug may be damaged.

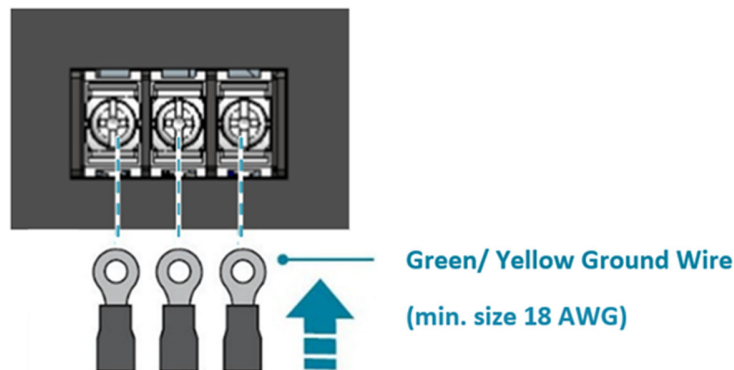

Figure 17.

4. Feed DC power into the system.  
The PSU will immediately output 12V and 5VSB to the system when a -36V to -75V DC power source is applied. The PSU has a built in 7 amperes, fast acting fuse based on the PSU maximum capacity, which will act as a second tier system protection in case the power distribution unit's fuse is not functioning.
5. Verify that the power supply is operating.  
If connected correctly, when turned on, the LED on the PSU will light up with a Green color designating normal operation.

## 7.2 AC Version

1. Ensure there is enough power to supply the system.  
The maximum system power consumption is 54 watts with an input voltage of 100-240V AC and 2 amperes. It is recommended to ensure that enough power is reserved from the power distribution system before installation. Also, please ensure that both PSUs have been properly installed before powering up the equipment, as the S9502-16SMT is designed to support 1 + 1 power redundancy.
2. Attach the power cable.  
Plug the power cord into the AC PSU and secure it tightly.
3. Verify that the power supply is operating.  
If connected correctly, when turned on, the LED on the PSU will light up with a Green color designating normal operation.

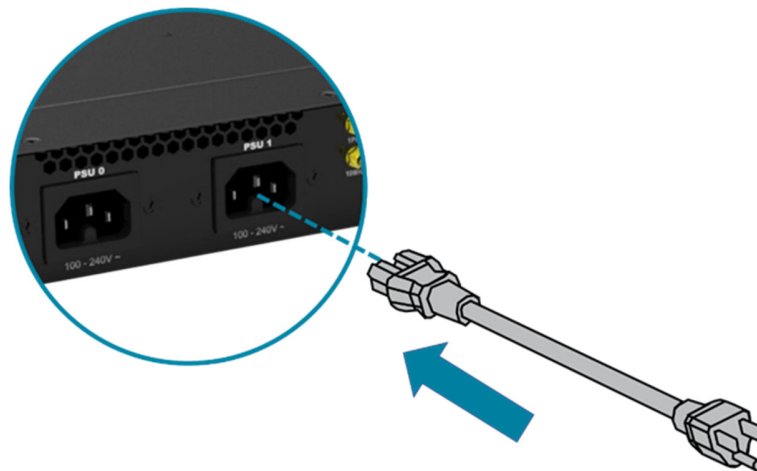

Figure 18.





## 8 Verifying System Operation

### 8.1 Front Panel LED

Verify basic operations by checking the system LEDs located on the front panel. When operating normally, the PWR and STAT LEDs should all display green.



Figure 19.

LED Condition	Equipment Status
<b>SYNC</b>	
Off	System timing synchronization is disabled or in free-run mode. **Note: need NOS to activate this feature
Solid Green	System timing core (1588 and SyncE) is synchronized to external timing source (ex: 1PPS, PTP, etc.) **Note: need NOS to activate this feature
Blinking Green	System is synchronized in SyncE mode. **Note: need NOS to activate this feature
Solid Yellow	System timing core is in acquiring state or holdover mode.
Blinking Yellow	System timing synchronization fail. **Note: need NOS to activate this feature
<b>STAT</b>	
Off	System (X86 & BMC) is initializing or not powered
Solid Green	System boot complete **Note: need NOS to activate this feature
Blinking Green	System is booting
<b>PSU</b>	
Off	Reserved
Solid Green	Both PSU1 and PSU2 are power good
Solid Yellow	PSU1 power is good, PSU 2 power is not good
Blinking Yellow	PSU1 power is not good, PSU2 power is good
<b>PWR</b>	
Off	System (X86 & BMC) is initializing or not powered
Solid Green	System power good & CPU board power good
Blinking Green	System power fail & CPU board power is good
Solid Yellow	System power good & CPU board power fail
Blinking Yellow	System power fail & CPU board power fail

## 8.2 Management port LED

LED Condition	Equipment Status
Left LED	
Off	1G No link
Solid Green	1G Link-up
Blinking Green	1G TX/RX activity
Right LED	
Off	No link
Solid Amber	10M/100M Link-up
Blinking Amber	10M/100M TX/RX activity



## 9 Initial System Setup

Establishing a first-time serial connection.

To assign an IP address, you must have access to the command line interface (CLI). The CLI is a text-based interface that can be accessed through a direct serial connection to the device.

Access the CLI by connecting to the console port. After you assign an IP address, you can access the system through Telnet or SSH by Putty, TeraTerm or HyperTerminal.

Perform the following steps to access the device through a serial connection:

1. Connect the console cable.
  - The console can be connected using the RJ45 port labelled IOIO.
  - To connect to console, plug a RJ45 serial cable into the console port and connect the other end to the computer. Cable types may vary depending on the model.

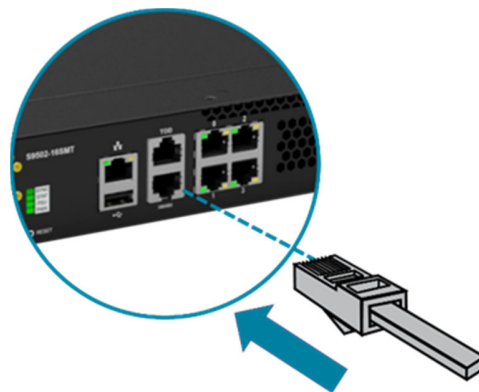

Figure 20.

2. Check for serial control availability.  
Disable any serial communication programs running on the computer such as synchronization programs to prevent interference.
3. Launch a terminal emulator.  
Open a terminal emulator application such as HyperTerminal (Windows PC), Putty or TeraTerm and configure the application. The following settings are for a Windows environment (other operating systems will vary):
  - Baud rate: 115200 bps
  - Data bits: 8
  - Parity: None
  - Stop bits: 1
  - Flow control: None
4. Login to the device.  
After the connection is established, a prompt for the username and password displays. Enter the username and password to access the CLI. The username and password should be provided by the Network Operating System (NOS) vendor.



## 10 Cable Connections

### 10.1 Connecting the USB Extender Cable

Connect the USB 2.0 A Type plug (male connector) into the USB port (female connector) located on the front panel of the router. The USB port is a maintenance port.

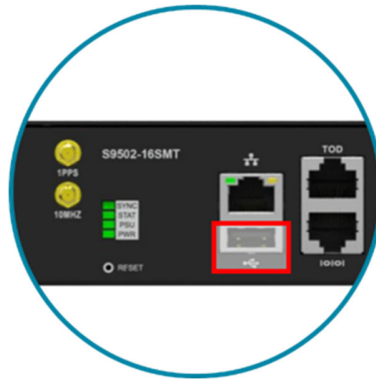

Figure 21.

### 10.2 Connecting a Cable to the ToD Interface



**Note**

The maximum length of the straight-through Ethernet cable should not be more than 3 meters.

1. Connect one end of a straight-through Ethernet cable to the GNSS unit
2. Connect the other end of the straight-through Ethernet cable to the port marked “TOD” located on the front panel of the router.

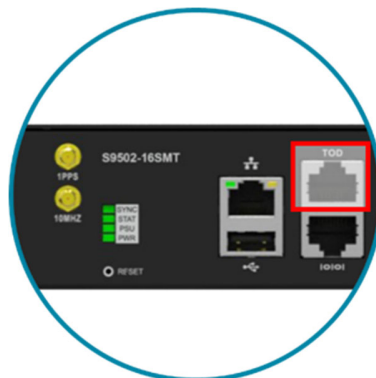

Figure 22.

### 10.3 Connecting the 1PPS Interface



**Note**

The maximum length of the 1PPS coaxial SMB/1PPS Ethernet cable should not be more than 3 meters.

Connect an external 1PPS cable with an impedance of 50 ohms to the port labelled “ 1PPS”.

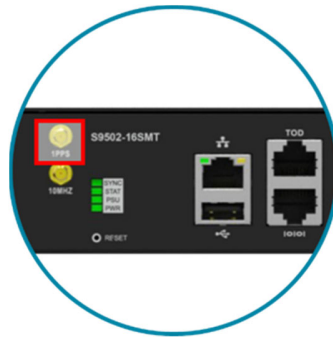

Figure 23.

### 10.4 Connecting the 10MHz Interface



**Note**

The maximum length of the 10MHz coaxial SMB cable should not be more than 3 meters.

Connect an external 10MHz cable with an impedance of 50 ohms to the port labelled "10MHz".

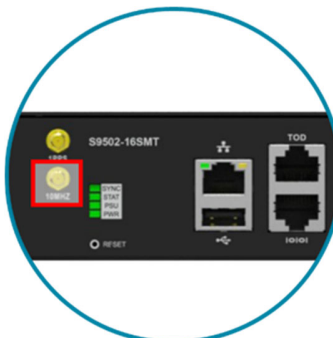

Figure 24.

### 10.5 Connecting the Transceiver



**Note**

To prevent over tightening and damaging the optic fibers, it is not

recommended to use tie wraps with optical cables.

Read the following guidelines before connecting the transceiver:

- Before installing the router, take into consideration rack space requirements for cable management and plan accordingly.
- It is recommended to use hook-and-loop style straps to secure and organize the cables.
- For easier management, label each fiber-optic cable and record its respective connection.
- Maintain a clear line of sight to the port LEDs by routing the cables away from the LEDs.



Before connecting anything (cables, transceivers, etc.) to the router, please ensure to discharge any static electricity that may have built up during handling. It is also recommended the cabling be done by a professional who is grounded, such as by wearing an ESD wrist strap.

Please follow the steps below for connecting a transceiver.

1. Remove the new transceiver from its protective packaging.
2. Remove the protective plug from the transceiver port.
3. Place the bail (wire handle) in the unlocked position and align the transceiver with the port.
4. Slide the transceiver into the port and use gentle pressure to secure it in place. An audible click can be heard when the transceiver is secured in the port.



## 11 Cautions and Regulatory Compliance Statements



### Safety Notices

#### Caution! Shock hazard!

TO DISCONNECT POWER, REMOVE ALL POWER CORDS FROM UNIT.



**Electrical Hazard:** Only qualified personnel should perform installation procedures.  
**Risques d'électrocution:** Seul un personnel qualifié doit effectuer les procédures d'installation.



**Warning:** Network Switch power supplies do not have switches for turning the unit on and off. Before servicing, disconnect all power cords to remove power from the device. Make sure that these connections are easily accessible.

**Avertissement:** Network Switch alimentations ne sont pas des interrupteurs pour allumer l'appareil et en dehors. Avant l'entretien, débranchez tous les cordons d'alimentation pour couper l'alimentation de l'appareil. Assurez-vous que ces connexions sont facilement accessibles.



**Caution:** Before mounting the device, ensure that the rack can support it without compromising stability. Otherwise, personal injury and/or equipment damage may result.



**Caution:** Use of controls or adjustments or performance of procedures other than those specified herein may result in hazardous radiation exposure.



**Caution:** Only Laser Class 1 optical transceivers shall be used.



**Warning:** Do not use optical instruments to view the laser output. The use of optical instruments to view laser output increases eye hazard. Use only UL/CSA, IEC/EN60825-1/-2 recognized pluggable modules.

**Avertissement:** Ne pas utiliser d'instruments optiques pour voir la sortie du laser. L'utilisation de instruments optiques pour afficher la sortie laser augmente les risques oculaires. Utilisez uniquement UL/CSA, IEC/EN60825-1 /-2 reconnu modules enfichables.



### Warning:

The equipment should only be used within a restricted access area.

The equipment should only be operated by skilled or instructed persons.

The equipment and its modules should only be repaired, maintained or replaced by skilled personnel.

Instructed person is a term applied to persons who have been instructed and trained by a skilled person, or who is supervised by a skilled person.

### Class A ITE Notice



This equipment is compliant with Class A of CISPR 32. In a residential environment this equipment may cause radio interference.

### VCCI Notice

This is Class A equipment. Operation of this equipment in a residential environment could cause radio interference. In such a case, the user may be required to take corrective actions.

この装置は、クラスA機器です。この装置を住宅環境で使用すると電波妨害を引き起こすことがあります。この場合には使用者が適切な対策を講ずるよう要求されることがあります。

VCCI-A

### 警告使用者：

此為甲類資訊技術設備，於居住環境中使用時，可能會造成射頻擾動，在此種情況下，使用者會被要求採取某些適當的對策。

此为A级产品，在生活环境中，该产品可能会造成无线电干扰。

在这种情况下，可能需要用户对干扰采取切实可行的措施。



The logo for ufiSpace, featuring the word "ufiSpace" in a bold, white, sans-serif font. The "i" in "ufi" has a dot, and the "S" in "Space" is larger and more prominent. The text is centered on a dark red background that is part of a larger graphic design with geometric shapes and a gradient.

**Unifying Cloud & Carrier Networks**

[www.ufispace.com](http://www.ufispace.com)