

Quick Start Guide

Ethernet Switch

AS4625-54T | AS4625-54P

Edge-core®

www.edge-core.com

Package Contents

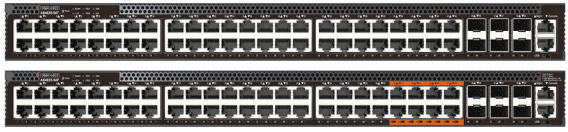

1



2



3



4



5



6



7

1. AS4625-54T/AS4625-54P (includes 2 PSUs)
2. Rack Mounting Kit—2 brackets and 8 screws
3. USB Micro-B to USB-A cable
4. Four adhesive rubber feet

5. Console cable—RJ-45 to DE-9
6. (Optional) AC power cord
7. Documentation—*Quick Start Guide* (this document) and *Safety and Regulatory Information*

Overview

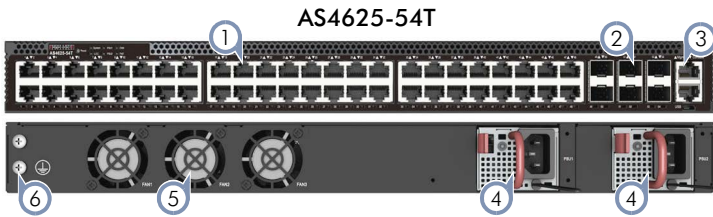

AS4625-54T

1. 48 x 1G RJ-45 ports
2. 6 x 1G/10G SFP+ ports
3. 1000BASE-T RJ-45, RJ-45 console, Micro-USB storage port
4. 2 x AC PSUs
5. 2+1 fixed redundant fans
6. Grounding screw

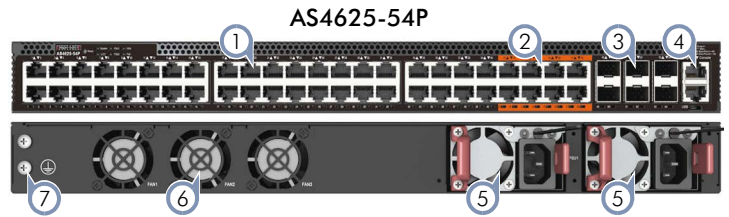

AS4625-54P

1. 40 x 1G RJ-45 PoE ports (30 W per port)
2. 8 x 1G RJ-45 PoE ports (90 W per port)
3. 6 x 1G/10G SFP+ ports
4. 1000BASE-T RJ-45, RJ-45 console, Micro-USB storage port
5. 2 x AC PSUs
6. 2+1 fixed redundant fans
7. Grounding screw

Status LEDs

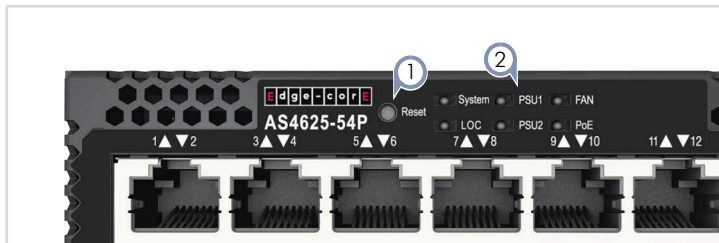

1. Reset button
2. System — Green (OK), Amber (fault detected)
PSU1/2 — Green (OK), Amber (fault)
FAN — Green (OK), Amber (fault)
LOC — Blinking Amber (switch locator)
PoE — Green (OK), Amber (near PoE budget)

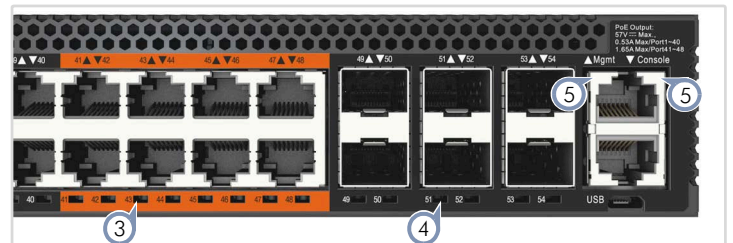

3. RJ-45 Port LEDs: Green (link), Amber (link with PoE)
4. SFP+ Port LEDs: Green (10G), Amber (1G)
5. RJ-45 Management Port LEDs: Left (link), Right (activity)

FRU Replacement



AS4625-54T

PSU Replacement

1. Remove the power cord.
2. Press the release latch and remove the PSU.
3. Install replacement PSU.

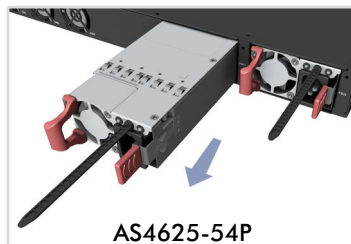

AS4625-54P

PSU Replacement

1. Remove the power cord.
2. Press the release latch and remove the PSU.
3. Install replacement PSU.



* 1 5 0 2 0 0 0 2 5 4 6 A R 0 1 *

Installation



Warning: For a safe and reliable installation, use only the accessories and screws provided with the device. Use of other accessories and screws could result in damage to the unit. Any damages incurred by using unapproved accessories are not covered by the warranty.

Avertissement: Pour une installation sûre et fiable, utilisez uniquement les accessoires et les vis fournies avec l'appareil. L'utilisation d'autres accessoires et vis pourrait endommager l'appareil. Les dommages causés par l'utilisation d'accessoires non approuvés ne sont pas couverts par la garantie.



Caution: The device must be installed in a restricted-access location.

Attention: L'appareil doit être installé dans un emplacement à accès restreint.



Note: The device has the Open Network Install Environment (ONIE) software installer preloaded, but no software image. Information about compatible software can be found at www.edge-core.com.



Note: The drawings in this document are for illustration only and may not match your particular model.

1 Mount the Device in a Rack

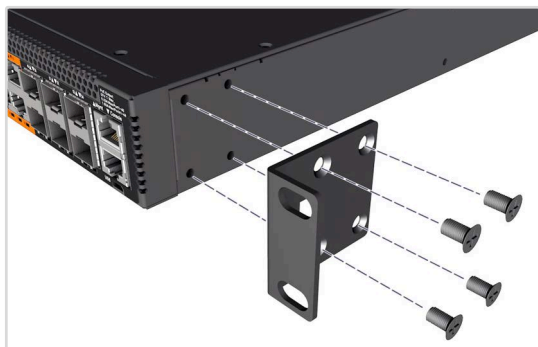

1. Use the included flathead M4x8 screws to attach the brackets.



2. Use the screws and cage/clip nuts supplied with the rack to secure the device in the rack.



Note: The device can also be installed on a desktop or shelf using the included adhesive rubber feet.

2 Ground the Device



Verify Rack Ground

Ensure the rack is properly grounded and in compliance with international and local standards. Verify that there is a good electrical connection to the grounding point on the rack (no paint or isolating surface treatment).

Attach Grounding Wire

Attach a grounding wire (#14 AWG/1.5 mm², green with yellow stripe) to the grounding point on the device's rear panel or side panel. Then connect the other end of the wire to rack ground.



Caution: The earth connection must not be removed unless all supply connections have been disconnected.

Attention: Le raccordement à la terre ne doit pas être retiré sauf si toutes les connexions d'alimentation ont été débranchées.

3 Connect Power

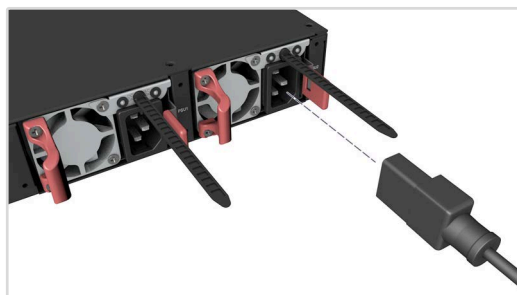

Install one or two AC PSUs in the device, if they are not already installed in the factory. Then connect an external AC power source to the PSUs.

4 Make Network Connections



RJ-45 Ports

Connect Category 5, 5e or better twisted-pair cable.

SFP+ Ports

Install transceivers and then connect fiber optic cabling to the transceiver ports. Alternatively, connect AEC/AOC/DAC cables directly to the SFP+ slots.

The following transceivers are supported in the SFP+ ports:

- 10GBASE-SR, LR, CR, T
- 1000BASE-SX, LX, T

5 Make Management Connections

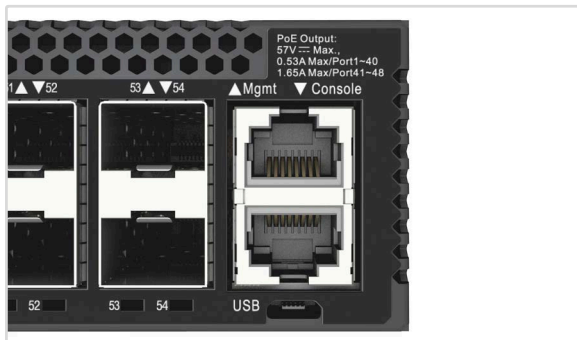

Micro-USB Port

Use the included Micro-USB cable to connect to an external storage device.

Mgmt RJ-45 Port

Connect Category 5, 5e or better twisted-pair cable.

RJ-45 Console Port

Use the included RJ-45-to-DE-9 null-modem console cable to connect to a PC running terminal emulator software. Use a USB-to-male DE-9 adapter cable (not included) for connections to PCs that do not have a DE-9 serial port.

Configure the serial connection: 115200 bps, 8 characters, no parity, one stop bit, 8 data bits, and no flow control.

Console cable pinouts and wiring:

Device's RJ-45 Console	Null Modem	PC's 9-Pin DTE Port
6 RXD (receive data)	<-----	3 TXD (transmit data)
3 TXD (transmit data)	----->	2 RXD (receive data)
4,5 SGND (signal ground)	-----	5 SGND (signal ground)

Hardware Specifications

Size (WxDxH)	440 x 350.35 x 44 mm (17.32 x 13.79 x 1.73 in.)
Weight	AS4625-54T: 5.8 kg (12.77 lb), includes two PSUs AS4625-54P: 6.6 kg (14.55 lb), includes two PSUs
Temperature	Operating: 0° C to 45° C (32° F to 113° F) Storage: -40° C to 70° C (-40° F to 158° F)
Humidity	Operating: 5% to 95% (non-condensing)
Power Consumption (at 25° C)	AS4625-54T: 150 W max. AS4625-54P: Low-line (90–136 VAC): 2000 Watts max. High-line (180–264 VAC): 2400 Watts max.
System Input Rating (per PSU)	AS4625-54T: 100–120 VAC, 50/60 Hz, 4 A max. 200–240 VAC, 50/60 Hz, 2 A max. AS4625-54P: 100–120 VAC, 50/60 Hz, 12 A max. 200–240 VAC, 50/60 Hz, 8.5 A max.
PoE Budget	AS4625-54P: Low-line: 850 W for 1 PSU, 1850 W for 2 PSUs High-line: 1050 W for 1 PSU, 1920 W for 2 PSUs

Regulatory Compliances

Emissions	EN 55032 EN 61000-3-2 EN 61000-3-3 FCC Title 47, Part 15, Subpart B, Class A VCCI-CISPR 32 BSMI Class A IECS-003 Issue 7 AS/NZS CISPR 32 KS C 9832
Immunity	EN 55024/EN 55035 KS C 9835 IEC 61000-4-2/3/4/5/6/8/11
Safety	UL (CSA 22.2 No 62368-1 & UL 62368-1) CB (IEC/EN 62368-1, 2nd & 3rd Ed) BSMI CNS 15598-1
Taiwan RoHS	CNS 15663

Warranty Information and Technical Support

Registering your product enables you to receive a more efficient warranty service. Be sure to register at www.edge-core.com.

快速入門指南

乙太網路交換器

AS4625-54T | AS4625-54P

Edge-core®

www.edge-core.com

包裝內容物



1



2



3



4



5



6



7

1. AS4625-54T/AS4625-54P (包括 2 部 PSU)
2. 機櫃安裝套件 — 2 個托架和 8 個螺絲
3. USB Micro-B 轉 USB-A 纜線
4. 四個黏性橡膠腳墊

5. 主控台纜線 — RJ-45 到 DE-9
6. (選配) AC 電源線
7. 文件 — 快速入門指南 (本文件) 及安全及法規資訊

簡介

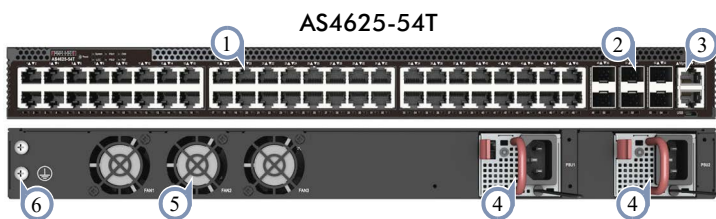

AS4625-54T

1. 48 x 1G RJ-45 連接埠
2. 6 x 1G/10G SFP+ 連接埠
3. 1000BASE-T RJ-45、RJ-45 控制埠、微型 USB 儲存埠
4. 2 x AC PSU
5. 2+1 固定備援風扇
6. 接地螺絲

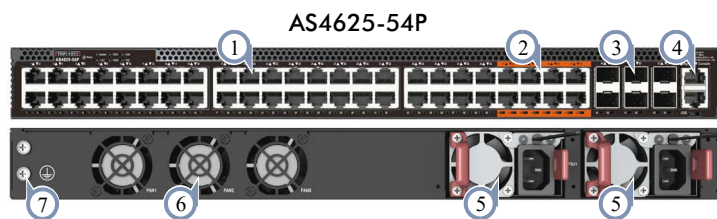

AS4625-54P

1. 40 x 1G RJ-45 PoE 連接埠 (每埠 30 W)
2. 8 x 1G RJ-45 PoE 連接埠 (每埠 90 W)
3. 6 x 1G/10G SFP+ 連接埠
4. 1000BASE-T RJ-45、RJ-45 控制埠、微型 USB 儲存埠
5. 2 x AC PSU
6. 2+1 固定備援風扇
7. 接地螺絲

LED 狀態

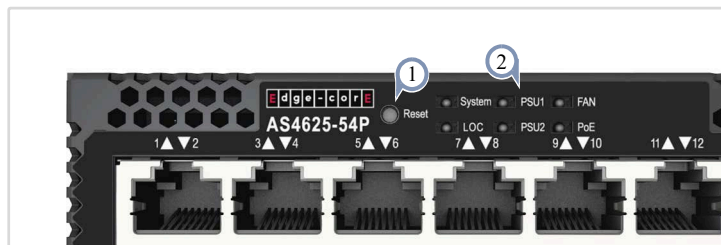

1. 重設按鈕
2. 系統 — 綠燈 (良好)、黃燈 (偵測到故障)
PSU1/2 — 綠燈 (良好)、黃燈 (故障)
風扇 — 綠燈 (良好)、黃燈 (故障)
LOC — 閃黃燈 (交換器定位器)
PoE — 綠燈 (良好)、黃燈 (接近 PoE 預算)

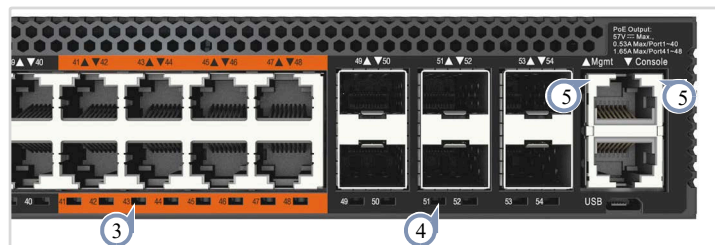

3. RJ-45 埠 LED：綠燈 (連接)、黃燈 (連接 PoE)
4. SFP+ 埠 LED：綠燈 (10G)、黃燈 (1G)
5. RJ-45 管理連接埠 LED：左 (連結)、右 (活動)

更換 FRU



AS4625-54T

更換 PSU

1. 取下電源線。
2. 按住釋放桿並取出 PSU。
3. 安裝更換的 PSU。

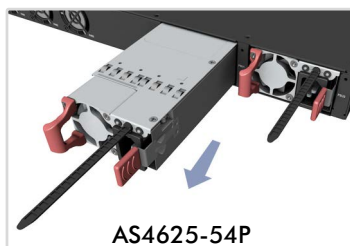

AS4625-54P

更換 PSU

1. 取下電源線。
2. 按住釋放桿並取出 PSU。
3. 安裝更換的 PSU。

安裝



警告：為確保安全且可靠的安裝，請使用裝置隨附的配件與螺絲。使用其他來源的配件與螺絲可能導致配件損壞。使用未經許可配件所造成之損壞，不在保固範圍內。



注意：裝置必須安裝在限制出入地點。



附註：本裝置預先安裝了「開放網路安裝環境 (Open Network Install Environment, ONIE)」軟體安裝程式，但沒有軟體圖示。關於相容軟體的資訊，可上此網站：www.edge-core.com。



附註：本文件中的示意圖僅供參考，可能與特定型號有所差異。

1 將裝置裝到機櫃中

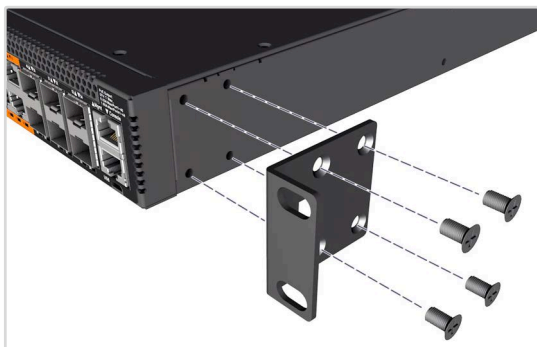

1. 使用內附的平頭 M4x8 螺絲安裝托架。



2. 使用機櫃隨附提供的螺絲與支架 / 彈簧夾螺帽將裝置固定於機櫃上。



附註：亦可利用內附之黏性橡膠腳墊，將此裝置安裝在桌上或層架上。

2 將裝置接地



確認機架接地

請確保機櫃正確接地，並符合國際與當地標準。確認與機櫃接地點間有良好的電氣連接性（無油漆或絕緣表面處理）。

安裝接地線

將接地線（#14 AWG/1.5 mm²，綠色及黃色條紋）安裝在裝置後面板或側面板接地點上。接下來，將接地線另一端連接至機櫃接地。



注意：在切斷所有電源接線前，不得移除接地連接。

3 連接電源

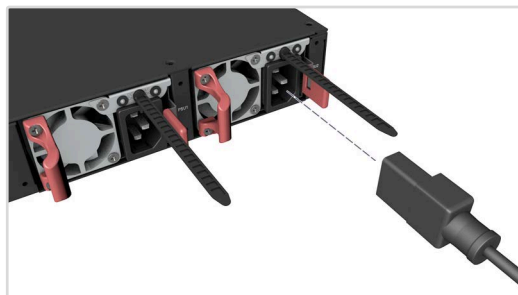

若尚未在原廠中安裝，請在裝置中安裝一或兩部 AC PSU。然後將外部 AC 電源連接至 PSU。

4 進行網路連線



RJ-45 埠

連接 Category 5、5e 或更好的雙絞線。

SFP+ 埠

安裝收發器，然後將光纖電纜連接至收發器連接埠。或可將 AEC/AOC/DAC 電纜直接連接至 SFP+ 插槽。

SFP+ 連接埠支援下列收發器：

- 10GBASE-SR、LR、CR、T
- 1000BASE-SX、LX、T

5 進行管理連接

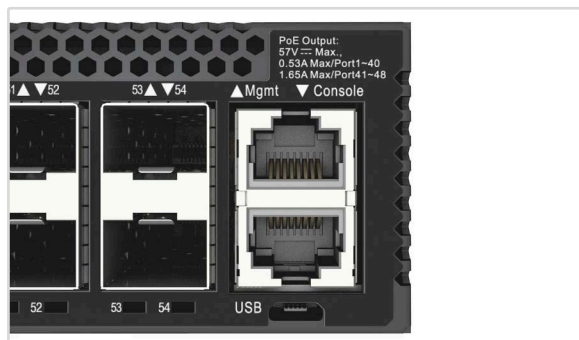

微型 USB 連接埠

利用隨附的微型 USB 纜線連接外部儲存裝置。

Mgmt RJ-45 連接埠

連接 Category 5、5e 或更好的雙絞線。

RJ-45 控制埠

利用隨附的 RJ-45-轉-DE-9 虛擬數據機電纜線來連接至執行虛擬終端機軟體的電腦。使用 USB-轉-公 DE-9 轉接纜線（未隨附）來連接至未配備 DE-9 序列埠的電腦。

設定序列連線：115200 bps、8 個字元、無奇偶（檢驗碼）、1 個停止位元、8 個資料位元，並且無流量控制。

主控台纜線接腳輸出及配線：

裝置的 RJ-45 主控台	虛擬數據機	電腦 9 接腳 DTE 連接埠
6 RXD（接收資料）	<-----	3 TXD（傳送資料）
3 TXD（傳送資料）	----->	2 RXD（接收資料）
4,5 SGND（訊號接地）	-----	5 SGND（訊號接地）

硬體規格

尺寸（寬 x 深 x 高） 440 x 350.35 x 44 毫米（17.32 x 13.79 x 1.73 英吋）

重量 AS4625-54T：5.8 公斤（12.77 磅），含兩部 PSU
AS4625-54P：6.6 公斤（14.55 磅），含兩部 PSU

溫度 操作：0°C 至 45°C（32°F 至 113°F）
儲存：-40°C 至 70°C（-40°F 至 158°F）

濕度 操作：5% 至 95%（無冷凝）

功耗（25°C 時） AS4625-54T：最大 150 W
AS4625-54P：
低壓線路（90–136 VAC）：最大 2000 瓦
高壓線路（180–264 VAC）：最大 2400 瓦

系統輸入額定值（每 PSU） AS4625-54T：
100–120 VAC，50/60 Hz，最大 4 A
200–240 VAC，50/60 Hz，最大 2 A
AS4625-54P：
100–120 VAC，50/60 Hz，最大 12 A
200–240 VAC，50/60 Hz，最大 8.5 A

PoE 預算 AS4625-54P：
低壓線路：850 W 適用於 1 部 PSU，1850 W 適用於 2 部 PSU
高壓線路：1050 W 適用於 1 部 PSU，1920 W 適用於 2 部 PSU

符合法規

輻射 EN 55032
EN 61000-3-2
EN 61000-3-3
FCC Title 47, Part 15, Subpart B, Class A
VCCI-CISPR 32
BSMI Class A
IECS-003 Issue 7
AS/NZS CISPR 32
KS C 9832

電磁耐受性 EN 55024/EN 55035
KS C 9835
IEC 61000-4-2/3/4/5/6/8/11

安全性 UL (CSA 22.2 No 62368-1 & UL 62368-1)
CB (IEC/EN 62368-1, 2nd & 3rd Ed)
BSMI CNS 15598-1

臺灣 RoHS CNS 15663