

Quick Start Guide

32-Port 400G Data Center Spine Switch
AS9716-32D

Package Contents

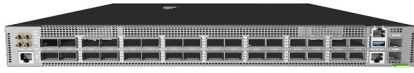

1



2



3



4



5

1. 32-Port 400G Data Center Spine Switch AS9716-32D
2. Rack mounting kit—2 front-post brackets, 2 rear-post brackets, 20 screws, and 2 ear-locking screws
3. Power cord (included with AC PSUs only)

4. Console cable—RJ-45 to DE-9
5. Documentation—*Quick Start Guide* (this document) and *Safety and Regulatory Information*

Overview

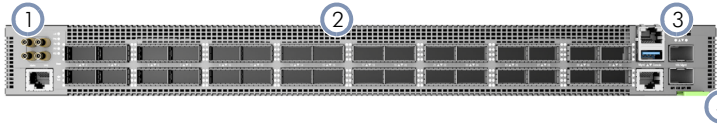

1. Timing ports: 10 MHz, 1PPS, ToD
2. 32 x 400G QSFP-DD ports
3. Management ports: 1 x 1000BASE-T RJ-45, 2 x 10G SFP+, RJ-45 console, USB

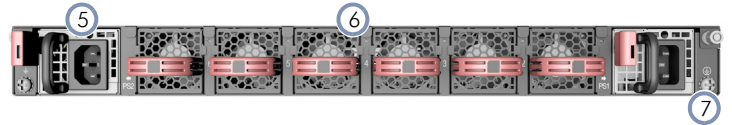

4. Product label
5. 2 x AC PSUs
6. 6 x fan trays
7. 2 x grounding screws

System LEDs/Buttons

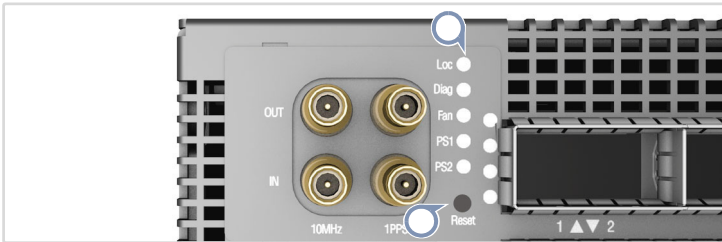

- PS1/PS2:** Green (OK), Amber (fault)
Diag: Green (OK), Amber (no OS or fault)
Fan: Green (OK), Amber (fault)
Loc: Flashing Amber (switch locator)
Reset Button

Port LEDs

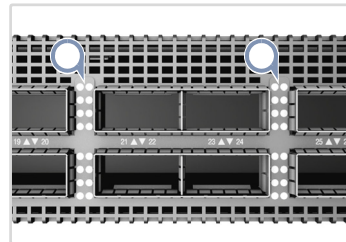

- QSFP-DD LEDs**
400G: 1 LED Blue
200G Breakout: 1 LED White,
1-2 LEDs Green
100G Breakout: 1-4 LEDs Green
50G Breakout: 1 LED Cyan

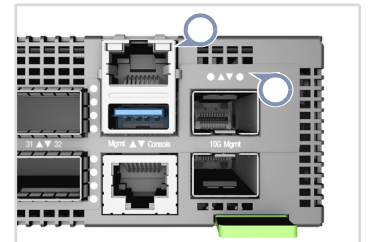

- SFP+ 10G Mgmt LEDs**
Green (10G)
Amber (1G)
RJ-45 Mgmt LED
Green (link/activity)

FRU Replacement

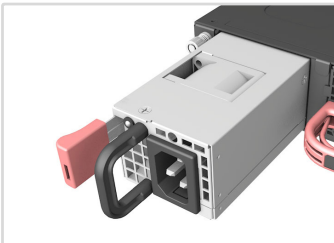

PSU Replacement

1. Remove the power cord.
2. Press the release latch and remove the PSU.
3. Install replacement PSU with matching airflow direction.

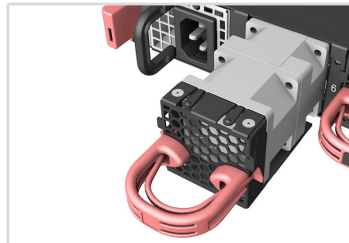

Fan Tray Replacement

1. Pull the handle release latch.
2. Remove fan tray from the chassis.
3. Install replacement fan with matching airflow direction.

Airflow Reversal

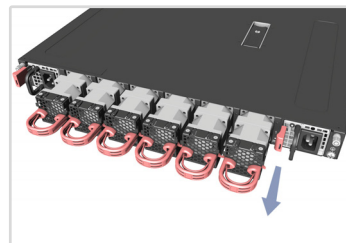

1. F2B Airflow

Remove front-to-back (F2B) airflow fan trays (red handles) and PSUs (red release latches).

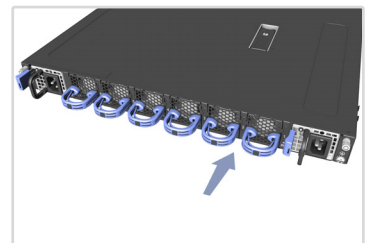

2. B2F Airflow

Install back-to-front (B2F) airflow fan trays (blue handles) and PSUs (blue release latches).

Installation



Warning: For a safe and reliable installation, use only the accessories and screws provided with the AS9716-32D. Use of other accessories and screws could result in damage to the unit. Any damages incurred by using unapproved accessories are not covered by the warranty.

Avertissement: Pour une installation sûre et fiable, utilisez uniquement les accessoires et les vis fournies avec le AS9716-32D. L'utilisation d'autres accessoires et vis pourrait endommager l'appareil. Les dommages causés par l'utilisation d'accessoires non approuvés ne sont pas couverts par la garantie.



Caution: The switch includes plug-in power supply (PSU) and fan tray modules that are installed into its chassis. Make sure all installed modules have a matching airflow direction (front-to-back or back-to-front).

Attention: Le commutateur comprend des modules d'alimentation et de modules de ventilation installés dans son châssis. Assurez-vous que tous les modules installés ont une direction d'air adaptée (avant-arrière ou arrière-arrière).



Note: The switch has the Open Network Install Environment (ONIE) software installer preloaded on the switch, but no switch software image. Information about compatible switch software can be found at www.edge-core.com.

Note: The switch drawings in this document are for illustration only and may not match your particular switch model.

1 Mount the Switch



Caution: This device must be installed in a telecommunications room or a server room.

Attention: Cet appareil doit être installé dans une salle de télécommunication ou une salle de serveur.

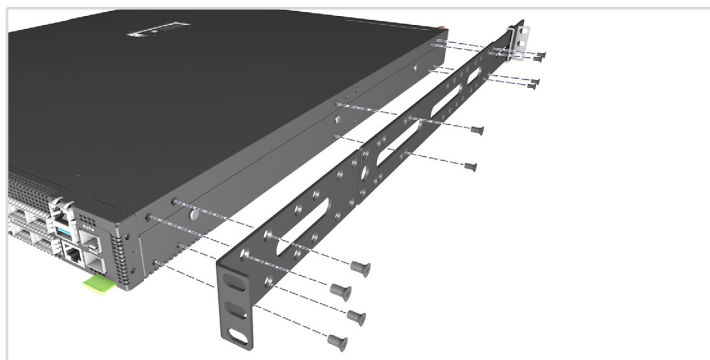

1. Attach the Brackets

Use the included screws to attach the front- and rear-post brackets.

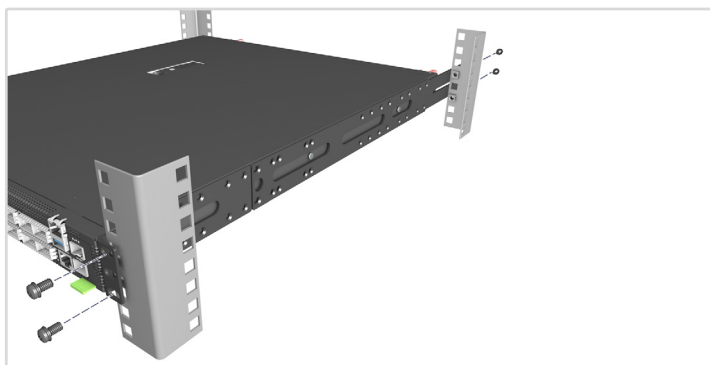

2. Mount the Switch

Mount the switch in the rack and secure it with rack screws.

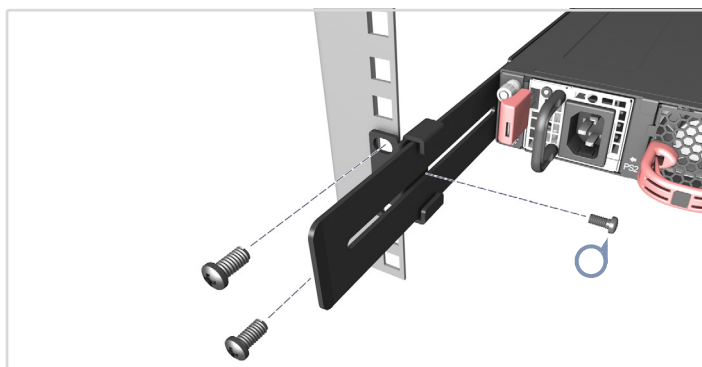

3. Lock the Rear-Post Brackets

Use the included screws to lock the position of the rear-post brackets.

2 Connect Power

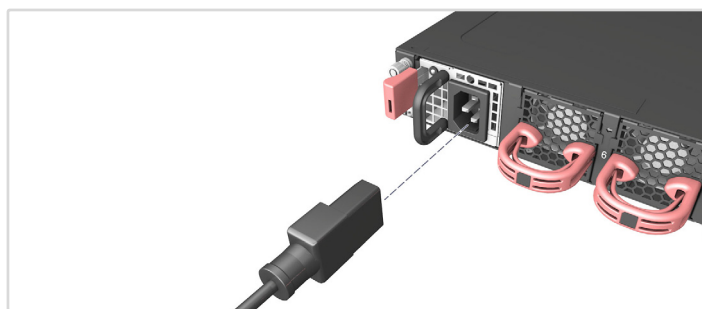

AC Power

Install one or two AC PSUs and connect them to an AC power source.



Caution: Use a UL/IEC/EN 60950-1 certified power supply to connect to a DC converter.

Attention: Utilisez une alimentation certifiée UL/IEC/EN 60950-1 pour le connecter à un convertisseur CC.

Caution: All DC power connections should be performed by a qualified professional.

Attention: Toutes les connexions d'alimentation CC doivent être effectuées par un professionnel qualifié.

3 Make Network Connections

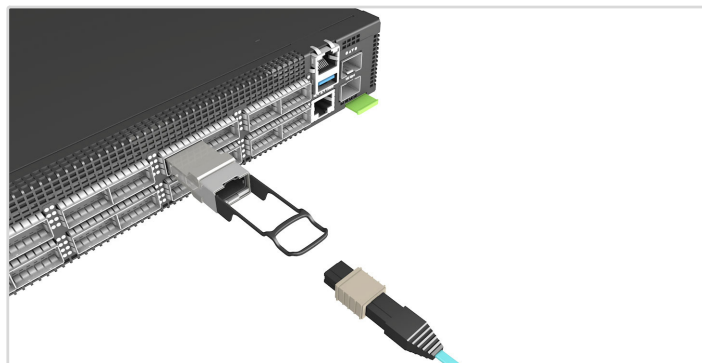

QSFP-DD Ports

Install transceivers and then connect fiber optic cabling to the transceiver ports.

Alternatively, connect DAC or AOC cables directly to the QSFP-DD slots.

4 Connect Timing Ports

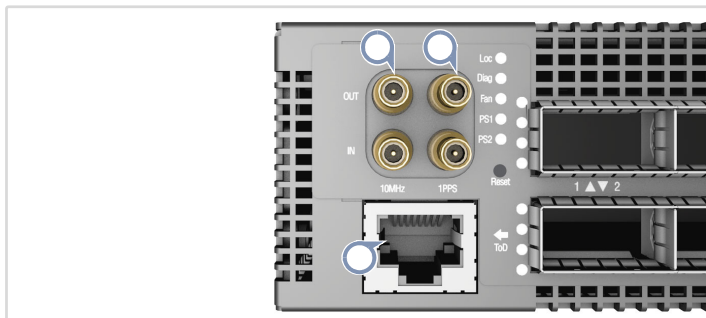

1PPS and 10 MHz Ports

Use coax cables to connect the 1-pulse-per-second (1PPS) and 10 MHz IN/OUT ports to other synchronized devices.

ToD Port

Use a shielded cable to connect the Time-of-Day (ToD) port to other devices that use ToD synchronization signals.

5 Make Management Connections

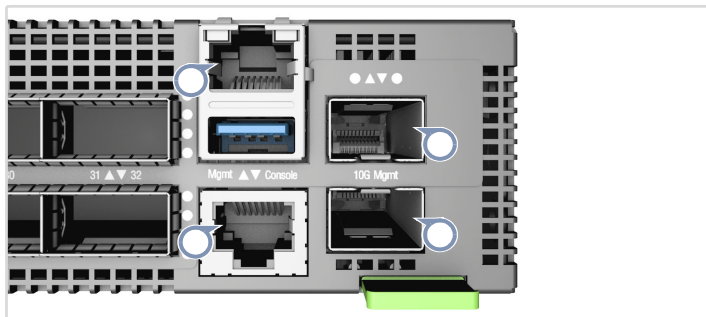

10/100/1000M RJ-45 Management Port

Connect Cat. 5e or better twisted-pair cable.

10G SFP+ Management Ports

Install transceivers and then connect fiber optic cabling to the transceiver ports.

RJ-45 Console Port

Connect the included console cable and then configure the serial connection: 115200 bps, 8 characters, no parity, one stop bit, 8 data bits, and no flow control.

Hardware Specifications

Switch Chassis

Size (WxDxH)	438.4 x 536 x 43.1 mm (17.26 x 21.1 x 1.7 in.)
Weight	11.06 kg (24.38 lb), with 2 PSUs and 6 fans installed
Temperature	Operating: 0° C to 45° C (32° F to 113° F) Storage: -40° C to 70° C (-40° F to 158° F)
Humidity	Operating: 5% to 95% (non-condensing)
Power Consumption	1300 Watts maximum

AC PSU

Input Power Rating	100–120 VAC, 50–60 Hz, 12 A max. 200–240 VAC, 50–60 Hz, 7.5 A max. 190–310 VDC, 8–5 A
--------------------	---------------------------------------------------------------------------------------------

Regulatory Compliances

Emissions	EN 55032:2015+AC:2016, Class A EN 61000-3-2:2014, Class A EN 61000-3-3:2013 FCC Class A VCCI Class A CCC GB 9254-2008, Class A
Immunity	EN 55035:2017 EN 55024:2010+A1:2015 IEC 61000-4-2/3/4/5/6/8/11
Safety	UL (CSA 22.2 No 62368-1 & UL62368-1) CB (IEC/EN60950-1 & IEC/EN 62368-1) CCC GB4943.1-2011

包装清单



①



②



③



④



⑤

1. 32 端口 400 数据中心节点交换机 AS9716-32D
2. 机架安装套件 — 2 个前柱支架，2 个后柱支架，20 个螺丝和 2 个吊耳螺丝。

3. 电源线（仅随交流 PSU 附带）
4. 控制台线 — RJ-45 转 DE-9
5. 文档 — *快速入门指南*（本文档）以及安全和管制信息

概述

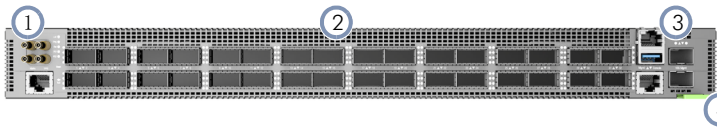

1. 计时端口：10 MHz、1PPS、ToD
2. 32 x 400G QSFP-DD 端口
3. 管理端口：1 x 1000BASE-T RJ-45，2 x 10G SFP+，RJ-45 控制台，USB

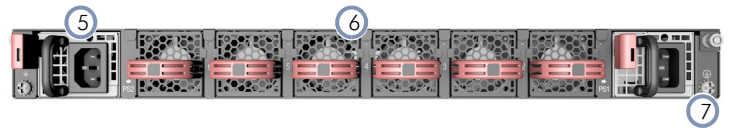

4. 产品标签
5. 2 x 交流 PSU
6. 6 x 风扇架
7. 2 x 接地螺丝

系统 LED/ 按钮

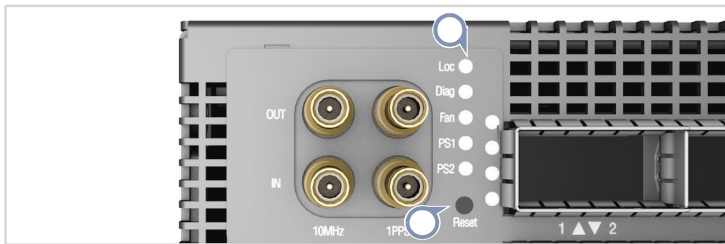

- PS1/PS2:** 绿色（正常），琥珀色（故障）
诊断: 绿色（正常），琥珀色（无 OS 或故障）
风扇: 绿色（正常），琥珀色（故障）
位置: 闪烁琥珀色（开关定位器）
重置按钮

端口 LED

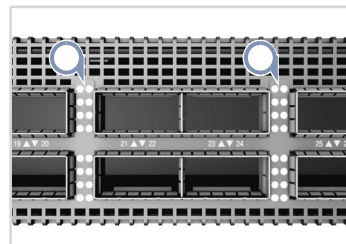

- QSFP-DD LED**
 400G: 1 LED 蓝色
 200G 断开: 1 LED 白色，
 1-2 LED 绿色
 100G 断开: 1-4 LED 绿色
 50G 断开: 1 LED 青色

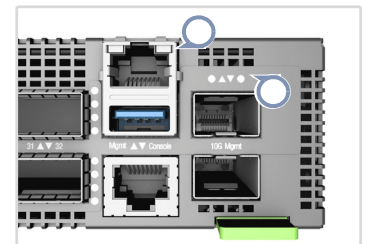

- SFP+ 10G 管理 LED**
 绿色 (10G)
 琥珀色 (1G)
RJ-45 管理 LED
 绿色 (连接 / 活动)

FRU 更换

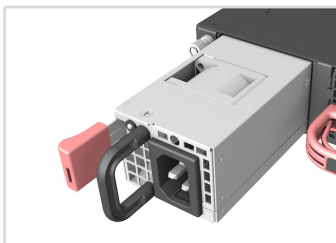

- PSU 更换**
1. 拔下电源线。
 2. 按下释放闩锁并卸下 PSU。
 3. 安装气流方向匹配的更换 PSU。

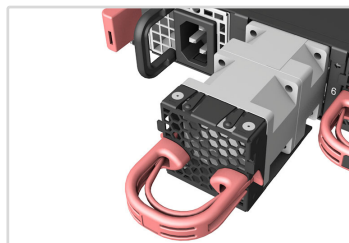

- 风扇架更换**
1. 拉一下把手释放闩锁。
 2. 从机箱中卸下风扇架。
 3. 安装气流方向匹配的更换风扇。

气流反向

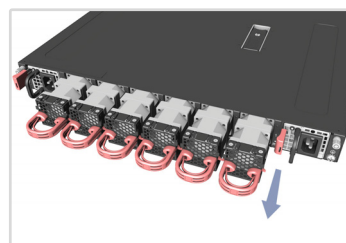

- 1.F2B 气流**
 安装从前到后（F2B）气流风扇架（红色手柄）和 PSU（红色释放闩锁）。

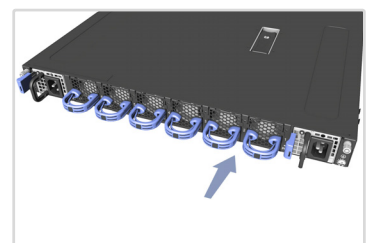

- 2.B2F 气流**
 安装从后到前（B2F）气流风扇架（蓝色手柄）和 PSU（蓝色释放闩锁）。

安装



警告：为了可以更安全的使用与安装机台，请务必使用 AS9716-32D 随货附赠的配件，避免导致设备损坏或其他风险产生。使用未经批准的配件造成的任何损坏，均不在保修范围内。



小心：本交换机的机箱中安装有插入式电源 (PSU) 和风扇架模块。确保所有安装的模块气流方向匹配（从前到后或从后到前）。



注意：本交换机上已预装了 Open Network Install Environment (ONIE) 软件安装程序，但没有交换机软件映像。在以下网站可以找到有关兼容交换机软件的信息：
www.edge-core.com。

注意：本文档中的交换机图示仅供参考，可能与您的具体交换机型号不符。

1 安装交换机



小心：此设备必须安装在电信机房或服务器机房。

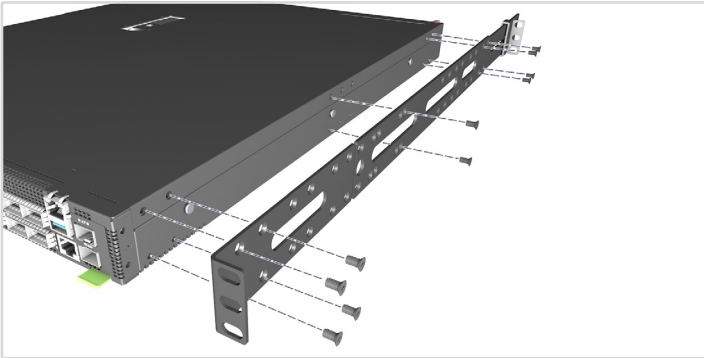

1. 安装支架

使用附带的螺丝安装前柱和后柱支架。

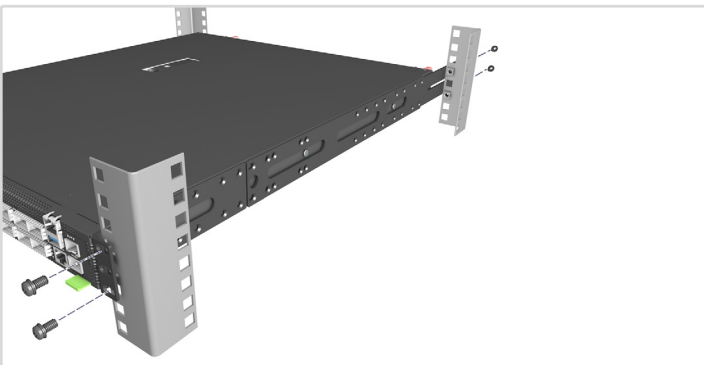

2. 安装交换机

将交换机安装在机架中，并用机架螺丝将其固定。

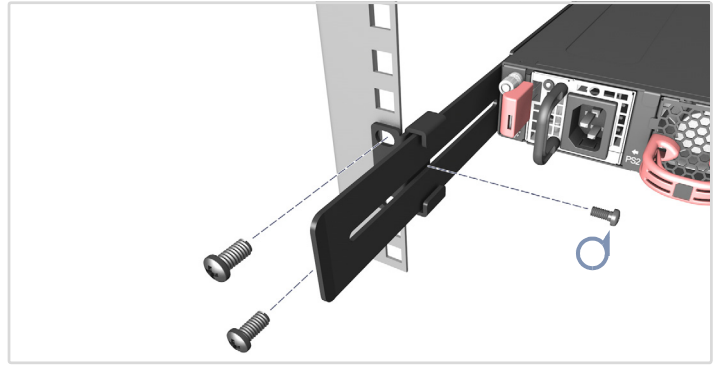

3. 锁定后柱支架

使用附带的螺丝锁定后柱支架的位置。

2 连接电源

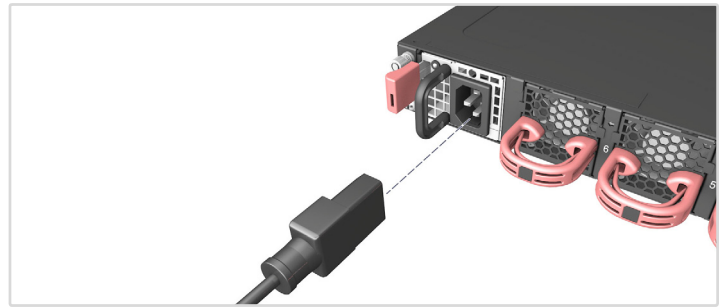

交流电源

安装一个或两个交流 PSU 并将其连接到交流电源。



小心：使用 UL/IEC/EN 60950-1 认证电源连接到直流转换器。

小心：所有直流电源连接应由合格的专业人员执行。

3 建立网络连接

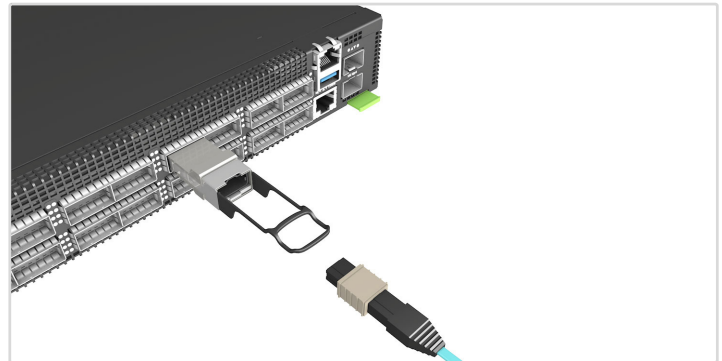

QSFP-DD 端口

安装收发器，然后将光缆连接到收发器端口。

或者，将 DAC 或 AOC 线缆直接连接到 QSFP-DD 插槽。

4 连接计时端口

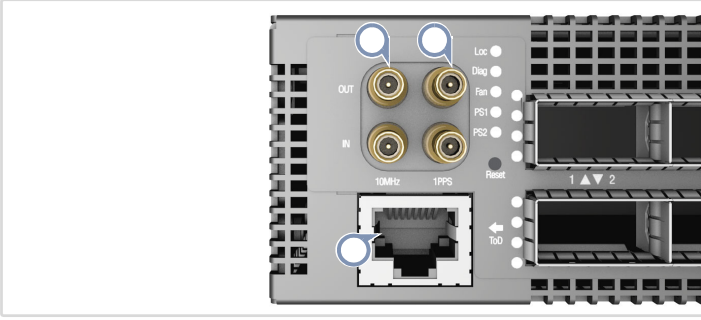

1PPS 及 10 MHz 端口

使用同轴线缆将每秒 1 脉冲（1PPS）和 10 MHz 输入 / 输出端口连接到其他同步设备。

ToD 端口

使用屏蔽线缆将当天时间（ToD）端口连接到使用 ToD 同步信号的其他设备。

5 建立管理连接

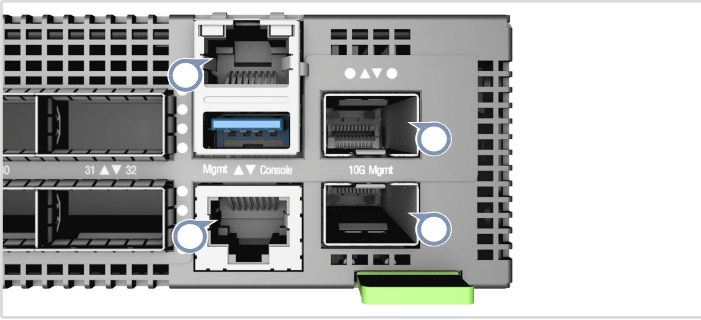

10/100/1000M RJ-45 管理端口

连接 5e 类或更好双绞线缆。

10G SFP+ 管理端口

安装收发器，然后将光缆连接到收发器端口。

RJ-45 控制台端口

连接附带的控制台线缆，然后配置串行连接：115200 bps，8 个字符，无奇偶校验，一个停止位，8 个数据位，无流量控制。

硬件规格

交换机机箱

尺寸 (WxDxH) 438.4 x 536 x 43.1 mm (17.26 x 21.1 x 1.7 英寸)

重量 11.06 kg (24.38 磅)，安装 2 个电源装置和 6 个风扇

温度 工作时：0° C 到 45° C (32° F 到 113° F)
存放时：-40° C 到 70° C (-40° F 到 158° F)

湿度 工作时：5% 到 95% (无冷凝)

功耗 最大 1300W

AC PSU

输入电源额定值 100–120 VAC, 50–60 Hz, 12 A 最大
200–240 VAC, 50–60 Hz, 7.5 A 最大
190–310 VDC, 8–5 A

管制符合性

辐射 EN 55032:2015+AC:2016, Class A
EN 61000-3-2:2014, Class A
EN 61000-3-3:2013
FCC Class A
VCCI Class A
CCC GB 9254-2008, Class A

抗干扰性 EN 55035:2017
EN 55024:2010+A1:2015
IEC 61000-4-2/3/4/5/6/8/11

安全 UL (CSA 22.2 No 62368-1 & UL62368-1)
CB (IEC/EN60950-1 & IEC/EN 62368-1)
CCC GB4943.1-2011